

Kit de refacciones para mantenimiento preventivo. / Kit of parts for preventive maintenance.

Rh-177

Rondana de Hule Chapetón  
Rubber Washer Escutcheon

Rf-045

Rondana de Fibra p/Tuerca de 32 mm  
Fiber Washer for 1 1/4" Nut

Rh-129

Tuerca p/ Cuerpos Laterales  
Side Nut BodiesSh-1114  
Valvex Flush Izquierdo  
Valvex V Flush Left

Sh-220

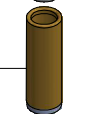
Extensión c/ Asiento p/ Cuerpo Lateral  
Extension with Seat for Lateral Body

Sh-1189

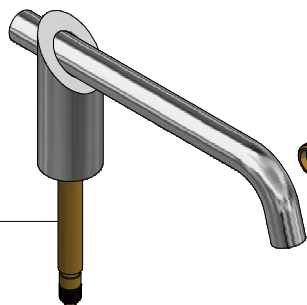
Adaptador para Salida  
Output Adapter

Rh-002

O'ring 2-012



Sv-604

Aireador Spray Oculto 0,5 GPM  
0,5 GPM Hidden Spray Aerator

Rr-291

O'ring 2-026

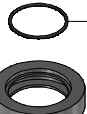

Rh-1210

Empaque Base  
Base Gasket

Rh-1459

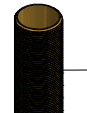
Espárrago Grande de Salida  
Large Shank

Rh-1473

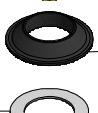
Separador Cuerpo Central  
Central Body Spacer

Rh-1472

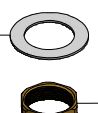
Rondana Acero Inoxidable  
Stainless Steel Washer

Rh-1471

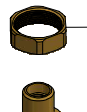
Tuerca Espárrago  
Asparagus Nut

Rh-2549

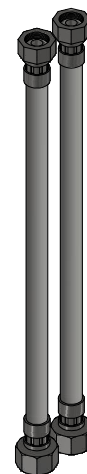
Cuerpo Central Tipo "Y"  
Central Body Type "Y"Rh-1486  
Llave Hexagonal 1-1/4"  
1-1/4" Hexagonal WrenchRh-1395  
Llave para Aireador  
Aerator Service Key

**Sub-ensambles / Sub-assemblies**

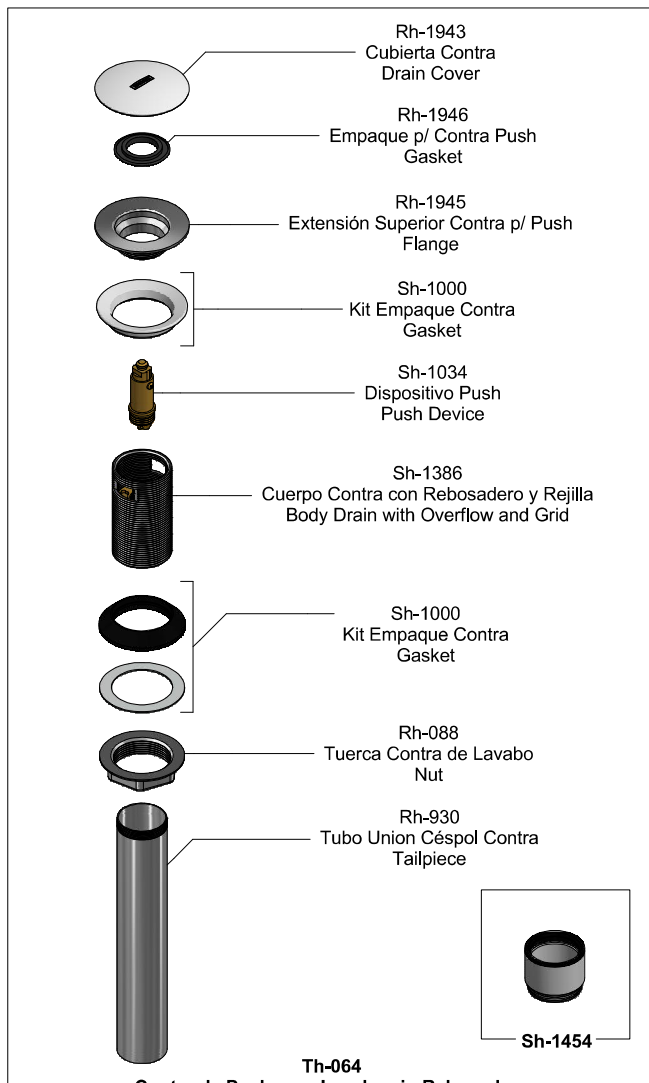

**Th-064**  
Contra de Push para Lavabo sin Rebosadero  
Push Drain Lavatory without Overflow

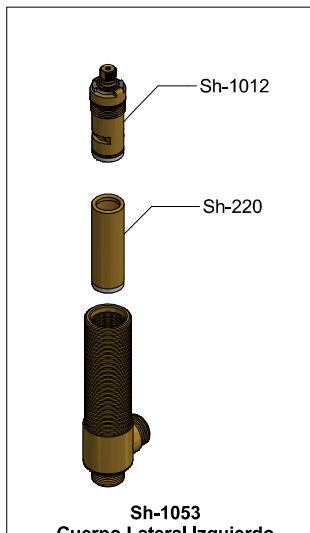

**Sh-1053**  
Cuerpo Lateral Izquierdo  
Body Left Side

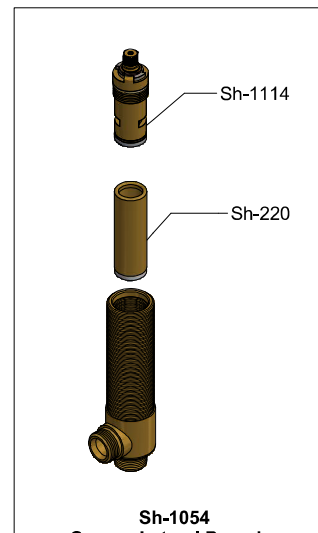

**Sh-1054**  
Cuerpo Lateral Derecho  
Body Right Side



**Sh-394**  
Manguera 1/2" NPSM-14 X 3/8" NPSM-18 X 12"  
1/2" NPSM-14 X 3/8" NPSM X-18 12" Hose

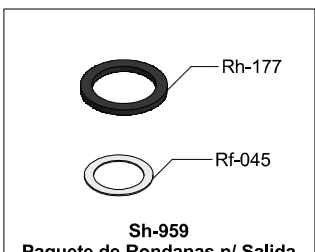

**Sh-959**  
Paquete de Rondanas p/ Salida  
Setting Kit Spout Washers

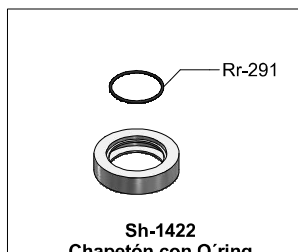

**Sh-1422**  
Chapetón con O'ring  
Escutcheon with O'ring

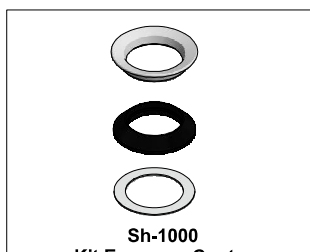

**Sh-1000**  
Kit Empaque Contra  
Gasket

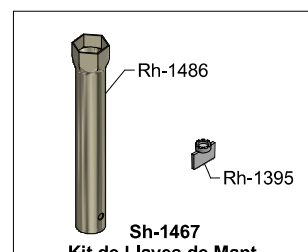

**Sh-1467**  
Kit de Llaves de Mant.  
Maintenance Keys Kit

